

Interpretations of the placement of the feet

1. Introduction

1.1. This paper discusses the meaning of some notation examples with the requirement of a certain exactness for notating a movement. The paper points out that the existence of the dialects of Kinetography Laban/Labanotation and the lack of the common and precise definitions cause different interpretations of the placement of the feet.

1.2. The placement of the feet on the floor has to be defined unambiguously since any symbol combination has to have a well-defined meaning in Kinetography Laban/Labanotation, if it is a consistent system.

1.3. The placement of the feet will be presented with footprint drawings with the aid of a grid.

1.4. A footprint is represented with an oval form, where the heel part is empty for the left foot and black for the right, see Szentpál 1976a p.20, fig.IV/1.

1.5. The length and the width of a footprint follow a 3:1 proportion in the drawings, see Szentpál 1976b p.4: “the proportion of the foot of an adult is 3:1”.

1.6. The exactness of the placement of a foot can be identified in the grid. A figure does not present the exactness in millimeter but it is a reasonable requirement that the placement of a foot has to be exact to one grid cell that is the width of a foot. One grid cell exactness can be a real requirement for the performance of the movement also.

1.7. When interpreting a kinetogram, the following components will be examined:
the movement type and the change in the support,
the rotation of the legs,
the direction of the movement and its reference point,
the distance of the movement and its calculation mode.

1.8. The distance between the feet supporting before and after the movement can be calculated in different ways, since two distance definitions exist, see 2.5 and 2.6 below, and only one of the definitions uses the same reference point that is used for the determination of the movement direction.

2. Step forward & normal distance

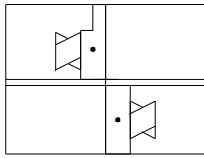

K1

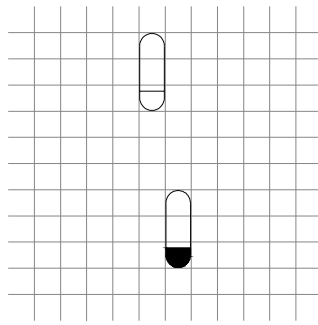

F1

2.1. According to K1, the movement is a step from the right leg to the left.

2.2. Both feet are parallel with the forward direction.

2.3. The direction of the step is forward. The forward direction sign does not mean that the left foot steps in front of the right foot. The whole body moves forward, and the left leg steps onto its own track, see Szentpál 1976a p.23 fig.1, Hutchinson 2005 p.54 fig.63a, Knust 1997 p.22, fig.136.

2.4. The distance is not indicated with a space measurement sign, which means a normal distance.

2.5. Mária Szentpál defines the distance of the feet as follows: “Dist. in steps are measured from one foot to the other (the two nearest points of supp.)”, see Szentpál 1976a p.36b. The normal distance is one foot length between the supporting feet, see Szentpál s.a. p.95 fig.109a-b.

2.6. According to the definition of Ann Hutchinson, the normal distance is two footlengths measured from the heel of a foot to the heel of the other foot, see Hutchinson 2005 p.142 fig.220, or from the center of a foot to the center of the other foot, see Hutchinson–Haarst 1991 p.120, fig.36a.

2.7. Using Szentpál’s distance definition, since a foot has a 3 unit length in the grid, a 3 unit gap has to be left between the two feet. Figure F1 shows this footprint drawing.

2.8. Using Hutchinson’s distance definition, 6 units have to be measured from heel to heel. The result is the same footprint drawing, see F1 figure.

2.9. K1 kinetogram results in F1 footprint drawing unambiguously.

3. Step in place & rotated feet

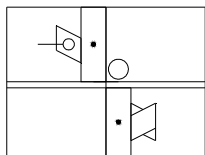

K2

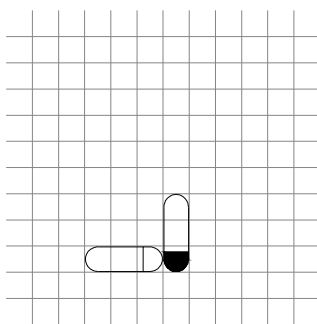

F2a

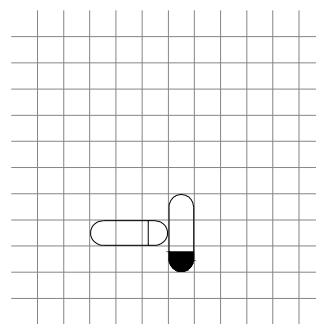

F2b

3.1. According to K2, the movement is a step from the right leg into a position.

3.2. The right foot is parallel with the forward direction and the left leg is turned outward 90 degrees.

3.3. The direction of the step is place. The left foot does not step onto the other foot but next to the right one on the left track. The result is a first position where the left leg is turned outward.

3.4. According to Mária Szentpál's definition in a first position rotated outward the two heels contact each other, see Szentpál 1976a p.91, fig.XI/16b. The placement of the feet is shown in F2a footprint drawing.

3.5. Another understanding of the first position results in another placement of the feet, as it is shown in F2b, where the centers of the feet are in side by side relationship, see Marion 1979 chart 4 fig.C11.

3.6. The different foot locations can be specifically stated by using a white or black side pin in accordance with the decision of ICKL, see ICKL 1979 p.58. K2a kinetogram results in F2a footprint drawing; K2b results in F2b.

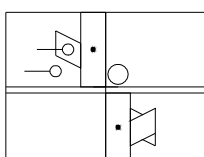

K2a

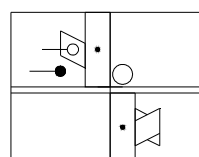

K2b

3.7. Notation practice in Hungary has applied black pins in the meaning of F2a after the decision of ICKL in 1979, see Szentpál 1987 p.2.

3.8. Without any pin, it is ambiguous whether K2 results in F2a or F2b footprint drawing.

4. Touching & place

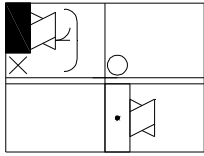

K3

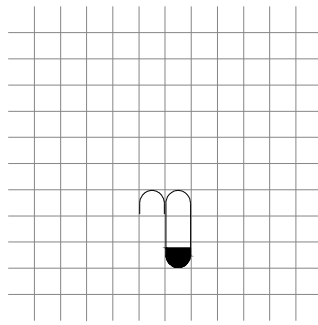

F3a

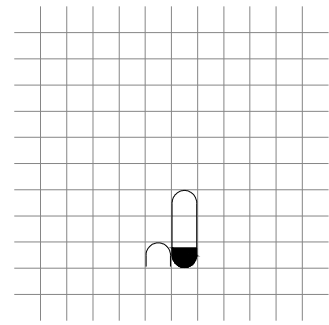

F3b

4.1. According to K3, the movement is a step into a position with the left leg bearing partial weight.

4.2. The touching gesture takes some partial weight. It can be taken as one-fourth weight (Szentpál 1976a p.60, fig.VIII/9) or one-third weight (Knust 1997 p.48, fig.223b). The amount of the weight is not relevant in the interpretation of the placement of the feet.

4.3. Both feet are parallel with the forward direction.

4.4. The direction of the touch is place; a half toe of the left foot touches the floor.

4.5. The 'Táncjelírás' book states that any part of the foot is understood to touch the floor in the place where that part of the foot would normally touch the floor with whole foot contact, that is where a step would be performed in accordance with the given direction sign, see Szentpál 1976a p.95, fig.XI/31c. F3a footprint drawing presents this understanding.

4.6. The 'Spatial Variations' book presents a different understanding, in which the half toe touches the floor beside the heel of the other foot, see Hutchinson Guest–Kolff p.180, fig.47bv-bw. Figure F3b shows this footprint drawing.

4.7. Knust's Dictionary contains only whole foot touch examples in place direction, and this situation is not discussed, see Knust 1997.

4.8. If the touching gesture is followed by a closing to the first position that has to be performed without any sliding, in Hutchinson's understanding an extra indication is needed for the 'preparatory touch', see Marion 1979 p.11.

4.9. If the touching gesture is not preparatory, see 4.8 above, K3 can result in F3a or F3b, and there is no distinguishing indication.

5. Step forward, normal distance & rotated feet

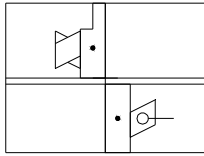

K4

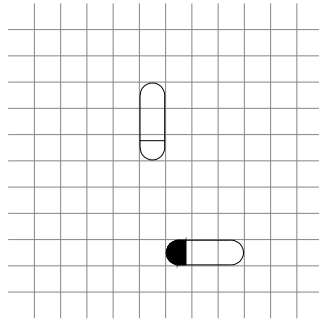

F4a

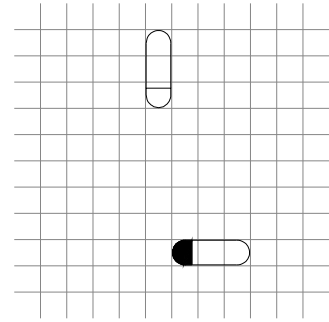

F4b

- 5.1. According to K4, the movement is a step from the right leg to the left.
- 5.2. The right leg is turned outward 90 degrees, the left foot is parallel with the forward direction.
- 5.3. The direction of the step is forward, and the left foot steps onto its own track.
- 5.4. The distance according to Szentpál is one footlength between the two feet. A 3 grid unit gap shows this distance in the F4a footprint drawing.
- 5.5. Using Hutchinson's specific distance definition, two footlengths are measured from heel to heel, and the footprint drawing is F4b, see also Hutchinson 1990 p.6 fig.3e-f.
- 5.6. The meaning of K4 is ambiguous.
- 5.7. There is no indication to distinguish and specify which of the two distance definitions is used.

6. Step forward & very small distance

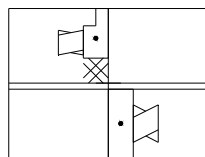

K5

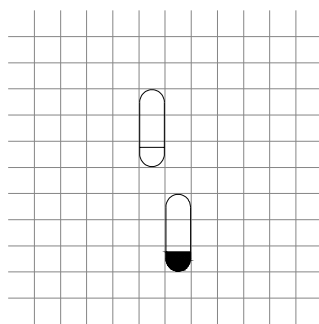

F5a

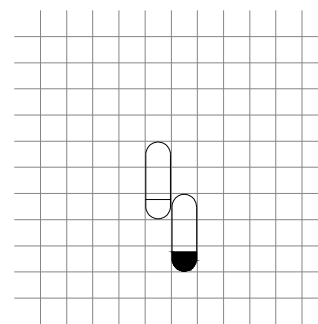

F5b

6.1. According to K5, the movement is a step from the right leg to the left.

6.2. Both feet are parallel with the forward direction.

6.3. The direction of the step is forward, the left foot steps onto its track.

6.4. The distance of the step is decreased as indicated by the space measurement sign.

6.5. There are different space measurement scales. Their differences are not discussed here, see Eckerle 1995.

6.6. Double X means that the step length is decreased to one-third of its normal length, regardless of whether Szentpál's three degree scale, see Szentpál 1976a p.36b fig.VI/6, or Hutchinson's or Knust's six degree scale is used, see Hutchinson 2005 p.141, fig.218, Knust 1997 p.254., fig.652.

6.7. The different possible meanings of K5 are attributable not to the different amount of the narrowness but rather to the different understanding of the 'null point' of the narrowness scale. The null point means the location of the foot where the narrowness reaches its maximum, and the distance reaches its minimum that is the distance of the feet is zero.

6.8. Using Szentpál's definition, the distance is zero, or in other words decreased maximally, if the feet touch each other, see 2.5 above. In this understanding, K5 results in F5a footprint drawing, where the distance is decreased from a 3 grid unit gap to its one-third that is 1 unit.

6.9. In the other understanding the distance of the feet is maximally decreased and equals zero, if two heels touch each other, see 2.6 above. As Knust writes, "the sixth degree of narrowness indicates 0 steplength or a step in place", see Knust 1997 p.254, or see Hutchinson 2005 p.141, fig.218. In the case of K5 the distance is decreased from 6 grid units to its one-third that is 2 units from heel to heel, as it is shown in the F5b footprint drawing.

6.10. The meaning of K5 is ambiguous.

6.11. Using Szentpál's definition, the distance indicated in K5c is a 1 unit gap. This is larger than the distance indicated in K5d, where the two feet touch each other at the beginning of taking a new support during the step, similarly to the fifth position.

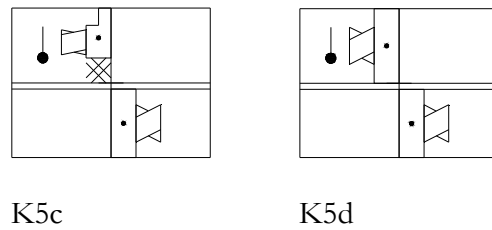

6.12. Using Hutchinson/Knust's definition, the distance indicated in K5c is 2 units from heel to heel. This is smaller than the distance indicated in K5d, see also Hutchinson–Haarst 1991 p.123, fig.36g. The movement notated in K5c cannot be performed in the Hutchinson/Knust's approach, since the left foot would step onto the right.

7. Spring forward & very small distance

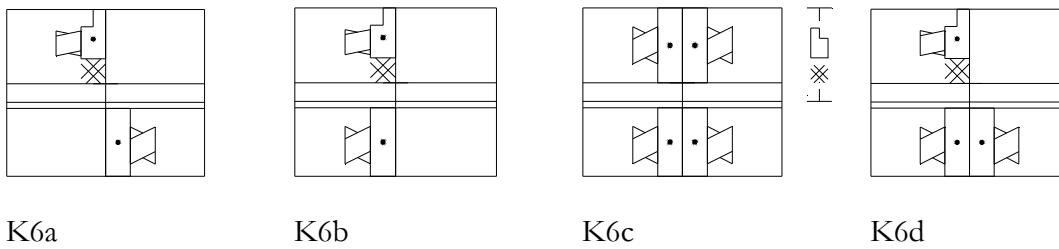

7.1. Each kinetogram above indicates a spring; K6a is a leap, K6b is a hop, K6c is a jump and K6d is a sissonne, see Hutchinson 2005 p.67.

7.2. Both feet are parallel with the forward direction.

7.3. The direction of each spring is forward.

7.4. The distance of each spring is decreased as indicated by the space measurement sign.

7.5. The distance of the step in K5 can be applied to K6a, the distance of K6a to K6b, K6b to K6c, and K6c to the distance of K6d, therefore one of the step distance definitions can be used for springs.

7.6. Using Hutchinson's definition, the distance of the K5 step is 2 units from heel to heel, see 2.6 above. The amount of the locomotion of K6a, K6b, K6c and K6d can be also calculated as 2 units regardless of whether one or two feet is used to start and end the spring.

7.7 Mária Szentpál defines the distance of a spring similarly to the distance of a step. “Dist. in steps are measured from one foot to the other (the two nearest points of supp.), in jumps, with the exception of one type ... likewise”, Szentpál 1976a p.36b. “There is however one type of jumps where this rule cannot be used; these jumps are progressing *sissonne* jumps taken from an open pos.”, Szentpál 1976a p.39. It is not clear why a jump from two feet to two feet is not mentioned as an exception, though the explaining figures present a jump type from two feet to two feet, see Szentpál 1976a p.39, fig.VI/8a-9a. Her footprint drawing is not proportionate and the gap is longer than a footlength, therefore unfortunately it does not help the understanding of the exceptional case in her definition.

7.8. Szentpál’s distance definition can be clearly applied to the K6a, K6b, K6c, K6d springs, since none of them starts from an open position. The gap is 1 grid between the feet, and the locomotion of the weight is 4 units in the forward direction with the given parallel rotations, as K5 step was illustrated with F5a.

7.9. In Szentpál’s approach, notating a forward spring in which the distance of the locomotion is shorter than a footlength, e.g. 2 grid units is difficult. To notate a distance shorter than a footlength Mária Szentpál applies the following indications:

- a) a space measurement sign beside a place direction sign, when a touching gesture closes to the supporting leg beyond a closing situation, see K7a, cf. Szentpál 1976a p.95, fig.XI/39.
- b) a black pin, in the meaning of a half footlength deviation in the case of the parallel foot rotation, see K7b, cf. Szentpál 1976a p.81-82, ex.X/18.
- c) a tack, which does not mean precise distance, see K7c, cf. Szentpál 1976a p.80, ex.X/11a.
- d) the fifth degree of the space measurement sign, using Hutchinson/Knust’s scale and null point, see K7d, cf. Szentpál 1976a p.80, ex.X/11b.

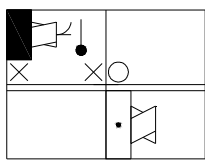

K7a

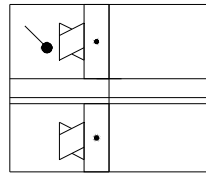

K7b

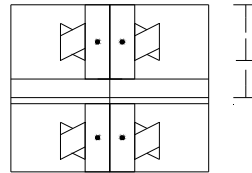

K7c

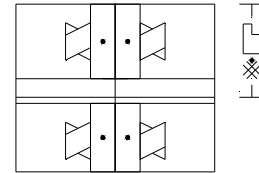

K7d

8. Step diagonal & very small distance

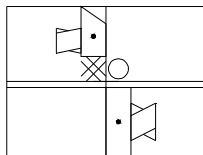

K8

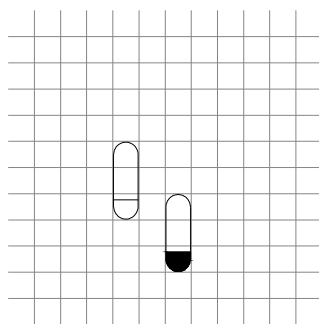

F8a

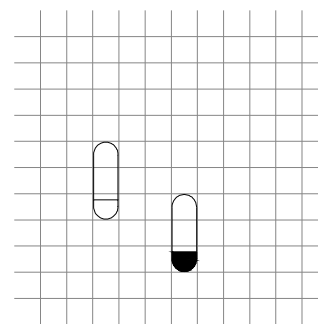

F8b

8.1. According to K8, the movement is a step into a position.

8.2. Both feet are parallel with the forward direction.

8.3. The direction of the step is diagonal, which results in a sixth position for Szentpál.

8.4. To have a closer look at the direction, in accordance with the ‘Táncjelírás’ book the line connecting the centers of the feet in the sixth position deviates 45 degrees from the forward direction, see Szentpál 1976a p.9, fig.I/7-8.

8.5. In the crossed sixth position the line connecting the centers of the feet deviates 45 degrees from the forward direction, see Szentpál 1976a p.9, fig.I/7-8, and Hutchinson–Haarst 1991 p.120, fig.36b.

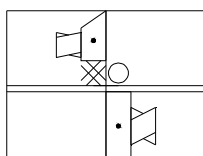

K8c

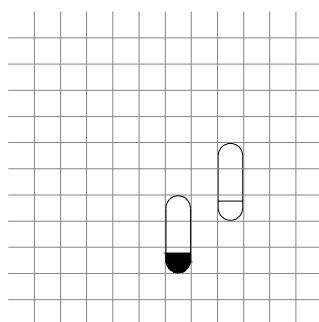

F8c

8.6. Although Mária Szentpál writes that “In the diagonal this problem does not face us”, see Szentpál 1965 p.6, it seems the track problem appears in the (not crossed) sixth position, see 8.7 below.

8.7. The footprint drawings presented in the ‘Kneeling, Sitting, Lying’ book are different from those in the ‘Táncjelírás’ book. While the crossed diagonal direction is determined in relation to the supporting foot, the diagonal direction is determined in relation to the imaginary place direction of the stepping foot, see Hutchinson–Haarst 1991 p.120, fig.36b. (It is not clear, whether from the heel or which part of the foot, if it is rotated). In any case the deviation of the line connecting the centers of the feet from the forward direction is not 45 degrees, see also Hutchinson–Haarst 1991 p.126, fig.36x.

8.8. In Szentpál's approach, the distance between the two feet in any position is calculated in the same way, see Szentpál s.a. p.95. Therefore the distance in the sixth position and the distance in the crossed sixth position are equal. The distance indicated by both K8 and K8c is one-third of the footlength that is 1 unit gap between the closest points of the feet.

8.9. In the other approach the distance is not exactly defined. The figures of the 'Kneeling, Sitting, Lying' book presents that the distance in the sixth position is larger than the distance in the crossed sixth position, see Hutchinson–Haarst 1991 p.120, fig.36b. In the 'Labanotation' book Hutchinson writes that "Forward steps are usually longer than sideward or backward steps and open steps are, of course, longer than crossing steps", see Hutchinson 2005 p.139.

8.10. In the light of the direction and the distance examined, see 8.5 and 8.8 above, K8c kinetogram results in F8c footprint drawing in the understanding of either Szentpál or Hutchinson.

8.11. In the light of the direction and the distance examined, see 8.4 and 8.8 above, K8 results in F8a footprint drawing in the understanding of Szentpál.

8.12. In the light of the direction and the distance examined, see 8.7 and 8.9 above, K8 results approximately in F8b footprint drawing in the understanding of Hutchinson.

8.13. The meaning of K8 is ambiguous.

8.14. There is no indication to distinguish the two meanings.

9. Spring forward from a position

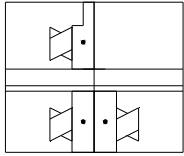

K9

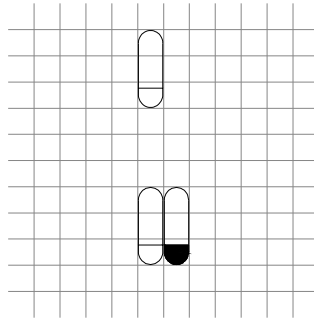

F9a

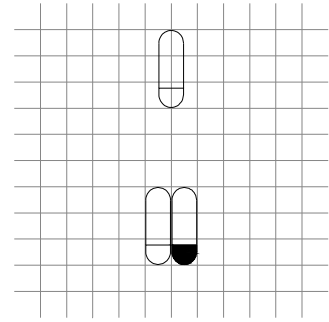

F9b

9.1. According to K9, the movement is a spring from both feet to the left foot.

9.2. Both feet are parallel with the forward direction.

9.3. The direction of the spring is forward. Since in the starting position both feet support, the reference point for the direction is the centre of the position, see Szentpál 1976a p.31, fig.V/16., Hutchinson 2005 p.70, Knust 1997 p.41 fig.213b.

9.4. In Szentpál's drawing the foot has to arrive onto a foot track beside the center line that runs through the center of the position, see Szentpál 1976a p36b, ex.V/16a.

9.5. In Hutchinson's drawing the center of the foot arrives onto the center line, see Hutchinson 2005 p.73 fig.97c. In Knust's drawing the placement of the feet is the same as that of Hutchinson, see ICKL 1973 p.15 fig.29b.

9.6. The distance of the spring is normal, see figures K1-F1 above.

9.7. K9 results in F9a footprint drawing in the understanding of Szentpál.

9.8. K9 results in F9b footprint drawing in the understanding of Hutchinson or Knust.

9.9. The meaning of K9 is ambiguous.

Bibliography

Eckerle, Christine (1995): The assessment of Distance in Supports in Kinetography Laban/Labanotation. European Seminar for Kinetography. Paper No. 13.

Hutchinson, Ann (1990): Measurement of Distance.
The Labanotator No.60, pp. 5-6.

Hutchinson Guest, Ann (2005): Labanotation. The System of Analyzing and Recording Movement. Fourth edition. Routledge, London, 2005.

Hutchinson Guest, Ann – van Haarst, Rob (1991): Kneeling, Sitting, Lying.
Advanced Labanotation. Volume 1, Part 3. Harwood Academic Publishers, London, 1991.

Hutchinson Guest, Ann – Kolff, Joukje (2003): Spatial Variations.
Advanced Labanotation. Issue 9. Dance Books, London, 2003.

ICKL (1973): Example Sheet for ICKL 1973 Conference Report.
In: Report of Conference of ICKL, Nonington, 1973. pp. 14-16.

ICKL (1979): Technical Report – ICKL 1979.
In: Proceedings of the Eleventh Biennial Conference of ICKL, Chantilly, 1979. pp. 58-61.

Knust, Albrecht (1997): A Dictionary of Kinetography Laban. Volume 1-2.
Second edition. Instytut Choreologii, Poznan, 1997.

Marion, Sheila (1979): Closed Positions of the Feet.
Pins. Paper 2. Paper for ICKL 1979. Manuscript.

Szentpál, Mária (1965): Position Pins Near Direction Symbols (The Centre Line Problem).
The Labanotator No.23, pp. 1-9.

Szentpál, Mária (1976a): Dance notation. Laban kinetography. Volume 1.
[Táncjelírás. Laban-kinetográfia. I.] English translation. Manuscript.

Szentpál, Mária (1976b): Black Pins for Foot Positions – Afterthoughts from Maria.
The Kinetographer No.11, p. 4.

Szentpál, Mária (1987): Specific Conventions, Symbols, Abbreviations in Hungarian Kinetograms.
Manuscript. Distributed at the Conference of ICKL, Namur, 1987.

Szentpál, Mária (s.a.): A mozgátelelemzés alapfogalmai. (The basic concepts of movement analysis.)
Népművelési Propaganda Iroda, Budapest, s.a.

Appendix. Referenced main figures

2.5 paragraph

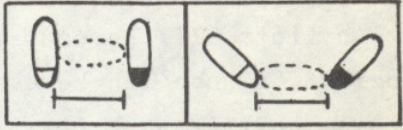

Szentpál s.a. p.95 fig.109a-b

2.6 paragraph

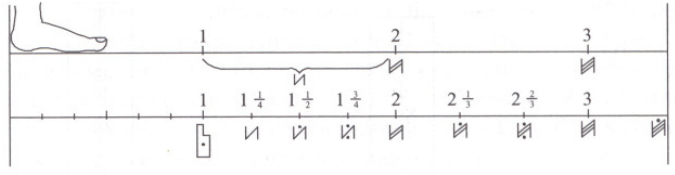

Hutchinson 2005 fig.220

3.4 paragraph

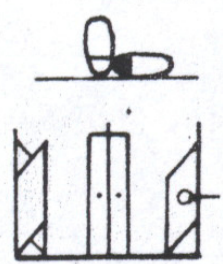

Szentpál 1976a fig.XI/16b

3.5 paragraph

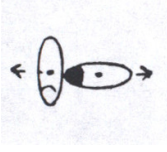

Marion 1979 chart 4 fig.C11

4.5 paragraph

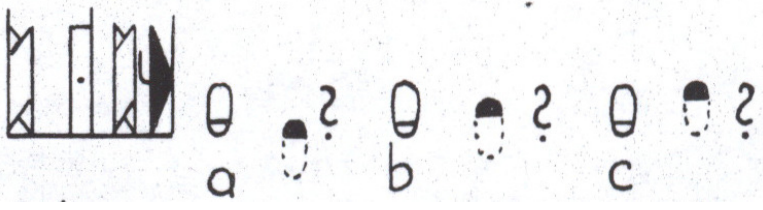

Szentpál 1976a fig.XI/31c

4.6 paragraph

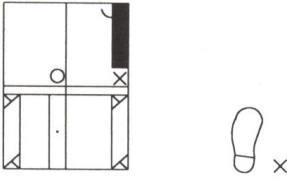

Hutchinson-Kolff fig.47bv-bw

4.8 paragraph

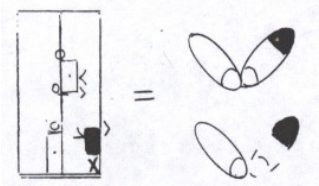

Marion 1979 p.11 fig. 'preparatory touch'

